

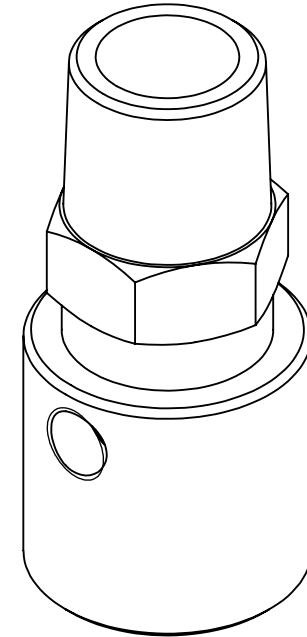

GENERAL TOLERANCES	ALL DIMENSIONS IN mm
NO DECIMAL PLACES = ±1.5	ANGULAR = ±2°
ONE DECIMAL PLACE = ±1.0	ALL UNSPECIFIED
TWO DECIMAL PLACES = ±0.5	ANGLES SHALL BE 45°

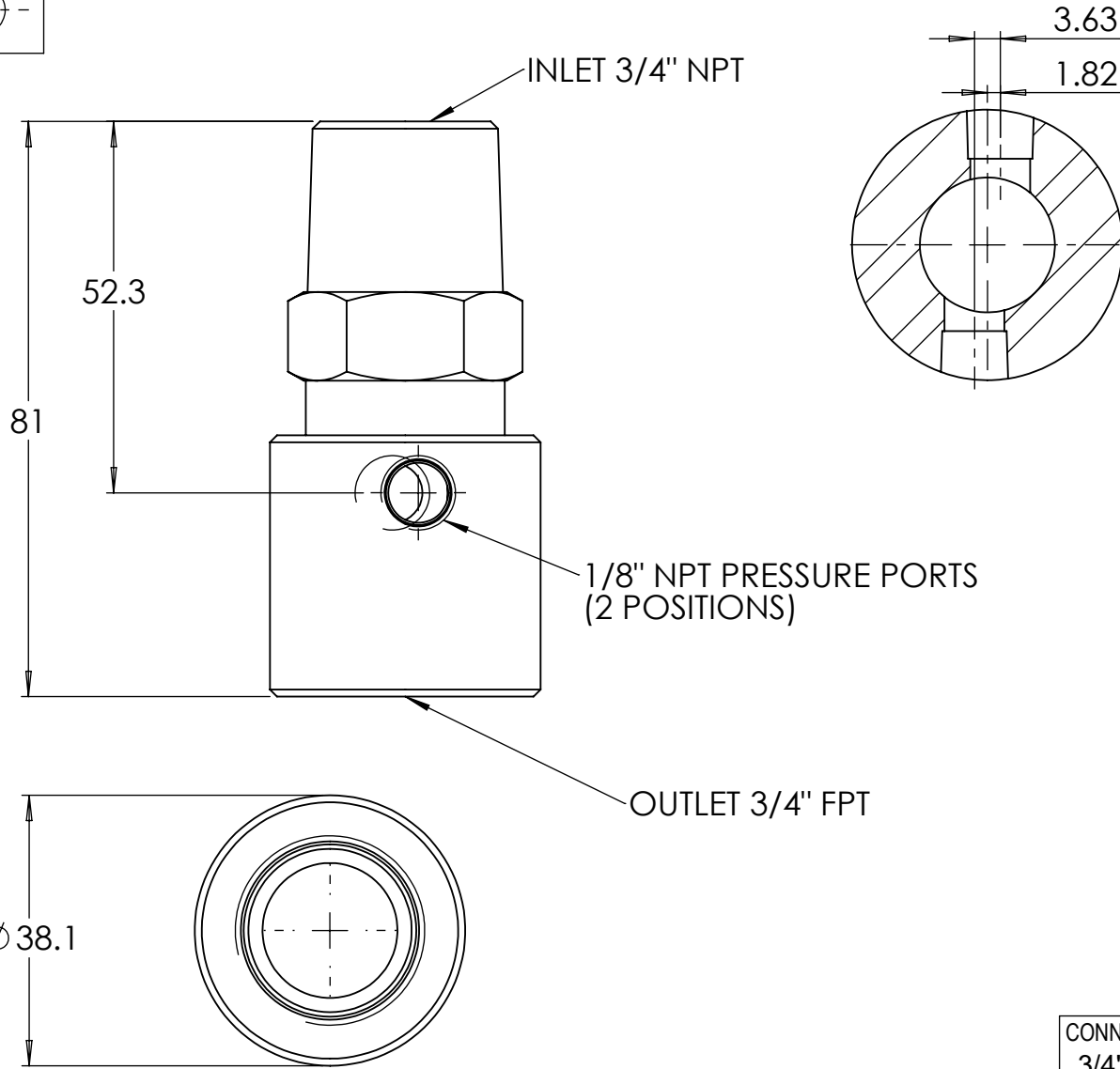

ISOMETRIC VIEW

NOTES:

1. HELIUM LEAK TESTED
2. SET PRESSURE RANGE: 10.3 to 130 barg
3. TEMPERATURE RANGE: -40 TO +427°C
4. UKCA/CE CERTIFICATION: CATEGORY IV

CONNECTION SIZE 3/4"	MATERIAL -
DESCRIPTION OF EQUIPMENT RUPTURE DISK ASSEMBLY	
PART NUMBER 5627	CURRENT ACTIVE REVISION A
SCALE 1:1	
DRAWN M. Rapach	
DATE 23/2/24	
CUSTOMER DRAWING	DRAWING No. 5627-Cust
	REVISION A