

HGI Part No.
208-0608

07/07/2020 HENRY
JTP *[Signature]*
APPROVED DOCUMENT

REV. 版本	ECN 工程变更通知	Description 变更描述	Name 变更人	Date 变更日期

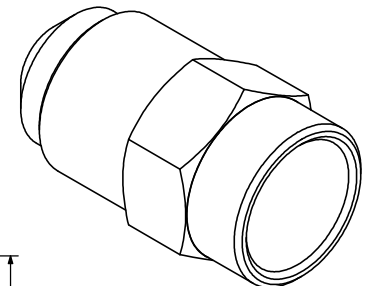
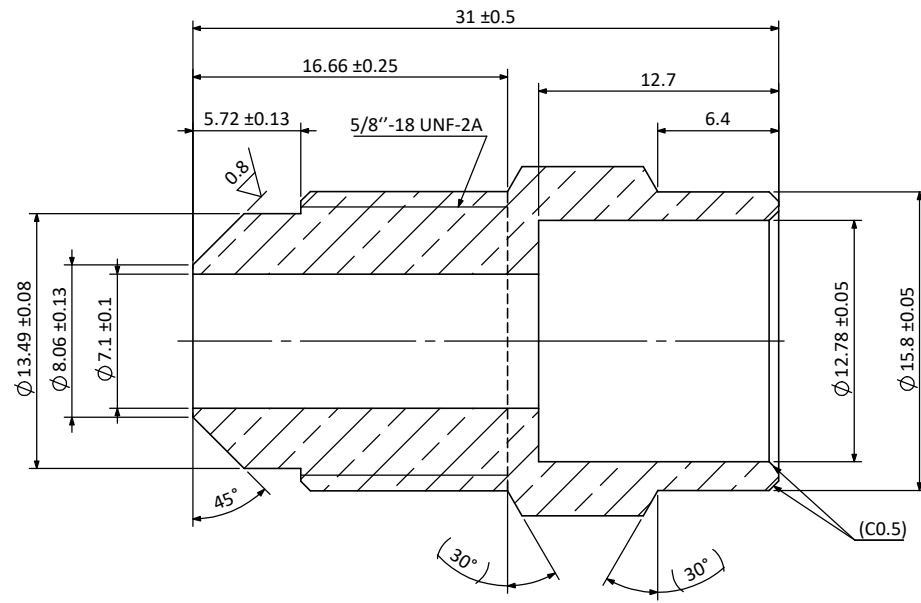
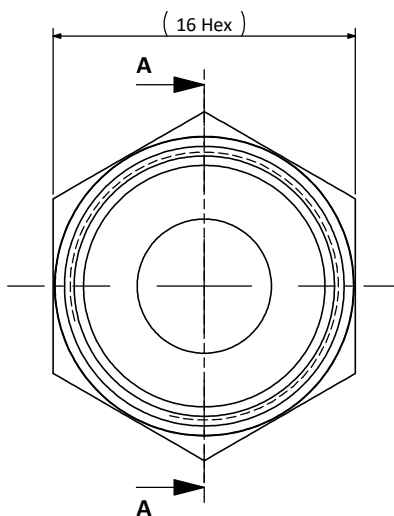

Section A-A

Technical Requirement:

技术要求:

- All edges free of burr or flash;
不能有毛刺和飞边;
- Surface should be clean and no rust(except oil stain);
表面应干净无生锈(油渍除外)
- Material certificates must be supplied each batch;
每批产品需提供材质分析报告;
- Unspecified geometric tolerance according to ISO 2768-K;
未注形位公差参照ISO-2768-K执行;
- Where is not specified, the thread must be within 1 pitch from the hex shoulder.
除有特殊说明, 螺纹到六角端面的距离应在1个螺距内;
- The hexagon opposite side must meet the outer diameter of the end.
六角对边尺寸必须满足端部外径尺寸。

Description 产品名称	Union 3/8" MSAE X 1/2" ID 接头 3/8" MSAE X 1/2" ID		
Drawing No. 图纸编号	M040202180	REV 版次	A
Material Master No. 物料编号	040202180	Drawing Size 图幅	A4
Material 材质	HPb59-1	Sheet Number 页码	1/1
Attribute 属性	3/8" MSAE X 1/2" ID	Third Angle Projection 第三视角	

Dimensions inside an oval are critical dimensions
椭圆内尺寸为关键尺寸

Linear Dimensions 线性尺寸	0 Decimal Place 整数	1 Decimal Place 1位小数	2 Decimal Place 2位小数	Angular Dimensions 角度尺寸	0 Decimal Place 整数	1 Decimal Place 1位小数	Ra 1.6	Estimated Weight 预估重量	29.50g		
	±1.0	±0.2	±0.05		±2°	±0.5°		Scale 比例	2:1	Unit 绘图单位	mm
Tolerance Unless Stated Otherwise 未注尺寸公差									Approved_by 批准	Julian Parker	2020/7/6
									Checked_by 审核	Leo Wu	2020/7/6
									Drawn_by 绘图	Angel Zhang	2020/6/29

