

HGI Part No.

219-0408

29/06/2020  HENRY
JTP 
APPROVED DOCUMENT

REV. 版本	ECN 工程变更通知	Description 变更描述	Name 变更人	Date 变更日期

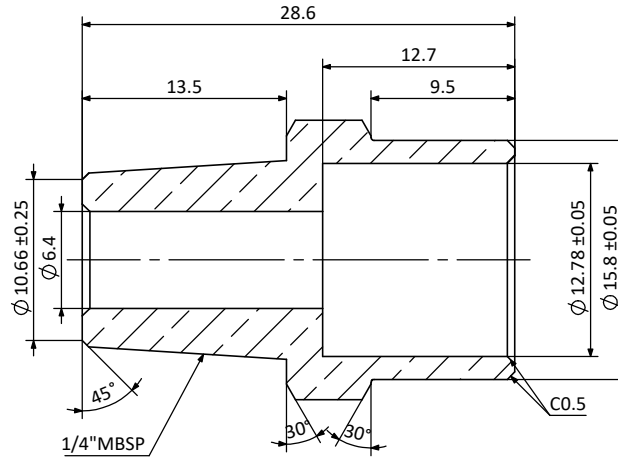
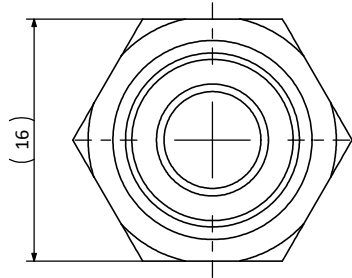

Section A-A

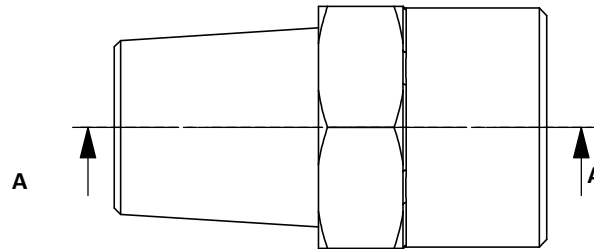
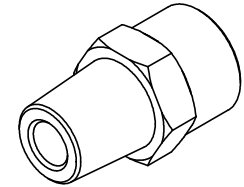

Technical Requirements:
技术要求:

- All edges free of burr or flash, 不能有毛刺和飞边;
- Where is not specified, the thread must be within 1 thread pitch from the hex shoulder, 除有特别说明, 螺纹到六角端面的距离应在一个螺距内;
- Forged parts to have hex faces broached for a machined finish, 零件由六角锻件加工而成;
- Unspecified geometric tolerance according to ISO 2768-K. 未注形位公差参照ISO 2768-K执行。

Description 产品名称		Union 1/4" MBSP×1/2" ID 接头 1/4" MBSP×1/2" ID	
Drawing No. 图纸编号	M040202247	REV 版次	A
Material Master No. 物料编号	040202247	Drawing Size 图幅	A4
Material 材质	HPb59-1	Sheet Number 页码	1/1
Attribute 属性	1/4" MBSP×1/2" ID	Third Angle Projection 第三视角	

Dimensions inside an oval are critical dimensions
椭圆内尺寸为关键尺寸

Linear Dimensions 线性尺寸	0 Decimal Place 整数	1 Decimal Place 1位小数	2 Decimal Place 2位小数	Angular Dimensions 角度尺寸	0 Decimal Place 整数	1 Decimal Place 1位小数	Ra 1.6 	Estimated Weight 预估重量	N/A		
	±1.0	±0.2	±0.05		±2°	±0.5°		Scale 比例	2:1	Unit 绘图单位	mm
Tolerance Unless Stated Otherwise 未注尺寸公差									Approved_by 批准	Julian Parker	6/28/2020
									Checked_by 审核	Leo Wu	6/28/2020
									Drawn_by 绘图	Qiu Leixin	6/28/2020

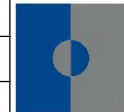

HENRY